

# YAMAHA

## GOLF CAR

OWNER'S/  
OPERATORS  
MANUAL

# G16A G16E

 **WARNING**

**The engine exhaust from this product contains chemicals known to the State of California to cause cancer, birth defects or other reproductive harm.**

YAMAHA

LIT-CALIF-65-01

## **INTRODUCTION**

Congratulations on your purchase of a Yamaha golf car. This manual contains information you will need for proper operation, maintenance, and care of your golf car. A thorough understanding of these simple instructions will help you to obtain maximum enjoyment from your new Yamaha.

If you have any questions about the operation or maintenance of your golf car, please consult a Yamaha dealer.

**TECHNICAL SERVICE DEPT  
GOLF CAR SALES GROUP  
YAMAHA MOTOR  
MANUFACTURING CORP OF  
AMERICA**

**G16A, G16E  
OWNER'S/OPERATOR'S  
MANUAL**

**© 2000 by Yamaha Motor  
Manufacturing Corporation  
of America**

**1st edition**

**All rights reserved. Any reprinting  
or unauthorized use without the  
written permission of  
Yamaha Motor Manufacturing  
Corporation of America  
is expressly prohibited.**

**Printed in U.S.A.**

**P/N LIT-19626-16-00**

# IMPORTANT MANUAL INFORMATION

Particularly important information is distinguished in this manual by the following notations:



The Safety Alert Symbol means **ATTENTION! BE ALERT! YOUR SAFETY IS INVOLVED!**

## **⚠ WARNING**

**Failure to follow WARNING instructions could result in severe injury or death to the golf car occupants, a bystander, or a person inspecting or repairing the golf car.**

## **CAUTION**

**This message describes special precautions that must be taken to avoid damage to the golf car.**

## **NOTE:**

This message provides additional key information.

## **NOTE:**

- Yamaha continually seeks advancements in product design and quality; therefore, while this manual contains the most current product information available at the time of printing, there may be minor discrepancies between your golf car and this manual. If you have any questions concerning this manual, please consult your Yamaha dealer.
- This manual should be considered a permanent part of your golf car and should remain with the car when resold.

## **⚠ WARNING**

**Read and understand this manual completely before operating your golf car.**

# CONTENTS

**WARRANTY**

**1**

**IMPORTANT LABELS**

**2**

**OPERATOR SAFETY**

**3**

**MAINTENANCE SAFETY PROGRAM**

**4**

**CONTROLS**

**5**

**PRE-OPERATION CHECKS**

**6**

**OPERATION**

**7**

**MAINTENANCE**

**8**

**STORAGE**

**9**

**SPECIFICATIONS**

**10**

**WIRING**

**11**

# WARRANTY

## YAMAHA MOTOR MANUFACTURING CORPORATION OF AMERICA G16A, G16E LIMITED WARRANTY

Yamaha Motor Manufacturing Corporation of America hereby warrants that any new G16 (gas and electric models) Yamaha Golf Car purchased from an authorized Yamaha dealer in the United States will be free from defects in material and workmanship for the period of time stated herein, subject to the stated limitations.

THE PERIOD OF WARRANTY for any G16 (gas and electric models) will be three years from date of purchase.

The first year of warranty shall cover the entire car except for batteries, battery chargers, tires and rims, which are warranted by their respective manufacturers.

The second year of warranty shall cover the engine assembly, clutch, transmission, axles, electrical system, frame, suspension components, electric motor, control cables, and steering gear.

Parts excluded from the second year of warranty include the body parts, seats, mats, bumper assembly, bag carrier, scorecard holder, and the trim.

The third year of warranty shall cover the engine assembly, clutch, transmission, axles, frame, suspension components, steering gear, and (on the G16E) electronic speed controller.

Parts excluded from the third year of warranty include the second year exclusions and the electrical system (except electronic speed controller), electric motor, and control cables.

DURING THE PERIOD OF WARRANTY any authorized Yamaha Golf Car Dealer will, free of charge, repair or replace, at Yamaha's option, any part adjudged defective by Yamaha due to faulty workmanship or material from the factory. Parts used in warranty repairs will be warranted for the balance of the machine's warranty period. All parts replaced under warranty become property of Yamaha Motor Manufacturing Corporation of America.

GENERAL EXCLUSIONS from this warranty shall include any failures caused by:

- a. Abnormal strain, neglect, or abuse, including lack of proper maintenance, and use contrary to the Owner's/Operator's Manual instructions.
- b. Accident or collision damage.
- c. Installation of parts or accessories that are not original equipment.
- d. Fading, rust, or deterioration due to exposure or ordinary wear and tear.
- e. Modification or alteration that affects the car's condition, operation, performance, or durability, or which makes the car serve a purpose other than use as a two-person, golf course vehicle.
- f. Damage due to improper transportation.
- g. Acts of God (i.e. lightning, hail damage, flooding, fire, etc.)

SPECIFIC EXCLUSIONS from this warranty shall include any parts replaced due to normal wear or routine maintenance; including oil, air filter elements, brake shoes, spark plugs, starter and clutch drive belts. Any charges incurred in transporting a golf car to and from an authorized Yamaha Golf Car Dealer for service or in performing field service is also excluded from this warranty.

THE CUSTOMER'S RESPONSIBILITY under this warranty shall be to:

1. Operate and maintain the golf car as specified in the appropriate Owner's/Operator's Manual;
2. Give notice to an authorized Yamaha dealer of any and all apparent defects within ten (10) days after discovery, and make the machine available at that time for inspection and repairs by the dealer's authorized representative.

WARRANTY TRANSFER: To transfer any remaining warranty from the original purchaser to any subsequent purchaser, it is imperative that the machine be inspected and registered for warranty by an authorized Yamaha Golf Car Dealer. In order for this warranty to remain in effect, this inspection and registration must take place within ten (10) days after transfer. An inspection and registration fee may be charged for this service.

YAMAHA MOTOR MANUFACTURING CORPORATION OF AMERICA MAKES NO OTHER WARRANTY OF ANY KIND, EXPRESSED OR IMPLIED. ALL IMPLIED WARRANTIES OF MERCHANTABILITY AND FITNESS FOR A PARTICULAR PURPOSE WHICH EXCEED THE OBLIGATIONS AND TIME LIMITS STATED IN THIS WARRANTY ARE HEREBY DISCLAIMED BY YAMAHA MOTOR MANUFACTURING CORPORATION OF AMERICA AND EXCLUDED FROM THIS WARRANTY.

SOME STATES DO NOT ALLOW LIMITATIONS ON HOW LONG AN IMPLIED WARRANTY LASTS, SO THE ABOVE LIMITATION MAY NOT APPLY TO YOU. ALSO EXCLUDED FROM THIS WARRANTY ARE ANY INCIDENTAL OR CONSEQUENTIAL DAMAGES INCLUDING LOSS OF USE. SOME STATES DO NOT ALLOW THE EXCLUSION OR LIMITATION OF INCIDENTAL OR CONSEQUENTIAL DAMAGES, SO THE ABOVE EXCLUSION MAY NOT APPLY TO YOU.

THIS WARRANTY GIVES YOU SPECIFIC LEGAL RIGHTS, AND YOU MAY ALSO HAVE OTHER RIGHTS WHICH VARY FROM STATE TO STATE.

YAMAHA MOTOR MANUFACTURING  
CORPORATION OF AMERICA  
Newnan, Georgia 30265-1320

Effective Date: 2/1/96  
LIT-13710-00-96

## YAMAHA MOTOR MANUFACTURING CORPORATION OF AMERICA SPECIALTY VEHICLE ENGINES EMISSION CONTROL WARRANTY

### YOUR WARRANTY RIGHTS AND OBLIGATIONS

In compliance with the California Air Resources Board, Yamaha Motor Manufacturing Corporation of America is pleased to explain the emission control system warranty on your 1996 or later specialty vehicle engine. New Yamaha specialty vehicle engines must be designed, built and equipped to meet stringent anti-smog standards. Yamaha must warrant the emission control system on your specialty vehicle engine for the periods of time listed below provided there has been no abuse, neglect or improper maintenance of your specialty vehicle engine.

Your emission control system may include parts such as the carburetor or fuel-injection system, the ignition system, and catalytic converter. Also included may be hoses, belts, connectors and other emission-related assemblies.

Where a warrantable condition exists, Yamaha will repair your specialty vehicle engine at no cost to you including diagnosis, parts and labor.

#### MANUFACTURER'S WARRANTY COVERAGE

The 1996 and later specialty vehicle engines are warranted for two years. If any emissions-related part on your engine is defective, the part will be repaired or replaced by Yamaha.

#### OWNER'S WARRANTY RESPONSIBILITIES

- As the specialty vehicle engine owner, you are responsible for the performance of the required maintenance listed in your owner's manual. Yamaha recommends that you retain all receipts covering maintenance on your specialty vehicle engine, but Yamaha cannot deny warranty solely for the lack of receipts or for your failure to ensure the performance of all scheduled maintenance.
- As the specialty vehicle engine owner, you should also be aware that Yamaha may deny you warranty coverage if your specialty vehicle engine or a part has failed due to abuse, neglect, improper maintenance or unapproved modifications.

- You are responsible for presenting your specialty vehicle engine to a Yamaha dealer as soon as a problem exists. The warranty repairs should be completed in a reasonable time, not to exceed 30 days.

If you have any questions regarding your warranty rights and responsibilities, you should contact the Yamaha Customer Relations Department at (770) 254-4164.

Yamaha Motor Manufacturing Corporation of America warrants to the ultimate purchaser and each subsequent purchaser thereafter that each new 1996 and later model year specialty vehicle engine certified for sale is:

1. Designed, built, and equipped so as to conform, at the time of sale, with all applicable regulations adopted by the California Air Resources Board, and
2. All warranted parts are free from defects in material and workmanship for the warranty period of the specialty vehicle engine or the period prior to the first scheduled replacement point of the warranted part as required by the maintenance schedule, if applicable, whichever is less. A defect exists when a deficiency in material or workmanship is such that an emission-related warranted part does not function as designed.

The warranty period begins on the date that the specialty vehicle engine is delivered to an ultimate purchaser or on the date it is first placed in service.

#### WARRANTED PARTS INCLUDE the following:

1. Fuel Metering System  
Carburetor and internal parts (or fuel injection)  
Air/fuel ratio feedback and control system  
Cold start enrichment system
2. Air Induction System  
Controlled hot air intake system  
Intake manifold

# WARRANTY

1

3. Ignition System  
Spark plugs \*  
Magneto or electronic ignition system  
Spark advance/retard system
4. Exhaust Gas Recirculation (EGR) System  
EGR valve body, and carburetor spacer if applicable  
EGR rate feedback and control system
5. Air Injection System  
Air pump or pulse valve  
Valves affecting distribution of flow  
Distribution manifold
6. Catalyst or Thermal Reactor System  
Catalytic converter  
Thermal reactor  
Exhaust manifold
7. Particulate Controls  
Traps, filters, precipitators, and any other device used to capture particulate emissions
8. Miscellaneous Items Used in Above Systems  
Vacuum, temperature, and time sensitive valves and switches  
Electronic controls  
Hoses, belts, connectors, and assemblies
9. Engine components damaged due to a failure under warranty of a warranted part.

\* The original spark plug(s) are warranted for the period of replacement indicated in the Owner's/Operator's Manual and not the useful life of the specialty vehicle engine (see your Owner's Manual).

## DURING THE PERIOD OF THIS WARRANTY

Yamaha Motor Manufacturing Corporation of America will repair or replace any warranted part deemed defective by Yamaha during the scope of the warranty without charge to the owner, including parts, labor, and diagnosis. This work must be done at an authorized Yamaha dealer. Give notice to an authorized Yamaha dealer of any apparent defect(s) within a reasonable period of time after discovery. The specialty vehicle engine must be made available for inspection by an authorized Yamaha dealer.

**OWNER'S RESPONSIBILITY:** The owner of the specialty vehicle engine is responsible for the performance of required maintenance (see your Owner's/Operator's Manual). Receipts and maintenance records covering the performance of regular maintenance should be retained in the event questions arise concerning maintenance. The receipts should be transferred to each subsequent owner of this specialty vehicle engine.

The emission control systems of your Yamaha specialty vehicle engine were designed, built, tested, and certified as being in conformity with California emission control regulations using genuine Yamaha parts. Accordingly, it is recommended that any replacement part(s) used for maintenance, replacement, or repair of emission control systems be Yamaha parts. The owner may elect to have maintenance, replacement, or repair of the emission control devices and systems performed by any repair establishment or individual, and may elect to use parts other than Yamaha parts for such maintenance, replacement, or repair without invalidating this warranty. However, the cost of such service or parts will not be covered under the warranty.

**EXCLUSIONS:** No warranty coverage will be allowed if the part(s) failure was caused by owner/operator abuse, neglect, tampering, improper adjustment unless performed by a dealer during warranty repair work, modification, misuse, alteration, or improper maintenance (see your Owner's/Operator's Manual).

Use of parts which are not qualitatively equivalent to genuine Yamaha parts, improper service, or lack of required maintenance which causes failure of a warranted part may constitute abuse and/or improper service, thereby invalidating warranty liability hereunder.

This warranty does not cover damage resulting from accidents, acts of nature, or other events or occurrences beyond the control of Yamaha. Yamaha Motor Manufacturing Corporation of America expressly disclaims responsibility for any and all consequential damages, such as loss of time, inconvenience, loss of use of the specialty vehicle, or commercial loss.

Yamaha Motor Manufacturing Corporation of America  
1000 Hwy. 34 East  
Newnan, GA 30265

# IMPORTANT LABELS

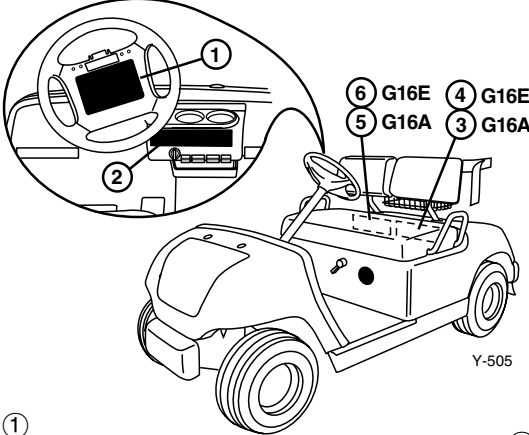

## SAFETY AND INSTRUCTION LABELS

### WARNING

Please read the following labels carefully before operating your golf car, and promptly replace any labels which become damaged or removed.

2

**1 OPERATING INSTRUCTIONS**

- Read the warning label on the beverage holder panel before operating.
- Be sure occupants are seated.
- Select "FORWARD" or "REVERSE" then turn main switch to "ON".
- Press the accelerator pedal to start moving. The motor will start and the parking brake will release automatically.
- To stop, release the accelerator pedal and press the brake pedal.
- Never travel at speeds too fast for the terrain, visibility conditions, or your experience.
- Drive with extra caution in congested areas, when operating in reverse, and when driving on wet, rough, or loose surfaces.
- Come to a complete stop before reversing direction.
- Press the parking brake pedal until it locks, and turn the main switch to "OFF" before leaving the vehicle.
- Read the Owner's/Operator's Manual for more information.

**ATTENTION**

- This vehicle was not manufactured for use on public streets and does not comply with federal motor vehicle safety standards applicable to passenger cars.

YAMAHA JJKK1718-01

**6 BATTERY INSTALLATION AND WIRE LEAD CONNECTION**

YAMAHA JN4-K7765-00

4 Y-500

Y-66

**WARNING/AVERTISSEMENT**

<p><b>EXPLOSIVE GASES</b></p> <p>are released when batteries are charged or discharged. Keep well ventilated. Keep sparks, flames and cigarettes away. Shield eyes when working near batteries.</p>	<p><b>LES GAZ EXPLOSIFS</b></p> <p>se dégagent lors de la charge ou du décharge des batteries. Garder bien ventilé. Garder éloignées, flammes et cigarettes à l'écart des batteries. Se protéger les yeux lorsque l'on travaille près des batteries.</p>	<p><b>SULFURIC ACID</b></p> <p>in batteries will burn skin, eyes, and clothing. Do not tip batteries. Keep vent caps tight and level. In event of injury, flush with water and call physician immediately.</p>	<p><b>L'ACIDE SULFURIQUE</b></p> <p>dans les batteries brûle la peau, les yeux, et les vêtements. Ne pas incliner les batteries. Garder les bouchons serrés et horizontaux. En cas de contact avec l'acide, rincer à grande eau et appeler le médecin immédiatement.</p>	<p><b>ELECTRICAL SHORTS</b></p> <p>can result in burns. Do not make connection between positive and negative battery terminals.</p>	<p><b>LES COURTS-CIRCUITS ELECTRIQUES</b></p> <p>peuvent causer des brûlures. Ne pas relier la borne positive et la borne négative d'une même batterie.</p>
-----------------------------------------------------------------------------------------------------------------------------------------------------------------------------------------------------	----------------------------------------------------------------------------------------------------------------------------------------------------------------------------------------------------------------------------------------------------------	----------------------------------------------------------------------------------------------------------------------------------------------------------------------------------------------------------------	--------------------------------------------------------------------------------------------------------------------------------------------------------------------------------------------------------------------------------------------------------------------------	-------------------------------------------------------------------------------------------------------------------------------------	-------------------------------------------------------------------------------------------------------------------------------------------------------------

YAMAHA JN4-K227-10

Y-770

**WARNING**

**DEATH OR SEVERE PERSONAL INJURY CAN RESULT FROM FAILURE TO FOLLOW THESE INSTRUCTIONS.**

- Read Operating Instructions on steering wheel before one starts.
- Operate only when authorized and only in designated areas.
- Operate from driver's side only.
- Do not allow more than two occupants in vehicle.
- Do not start vehicle until all occupants are seated.
- Remain seated and hold on when in motion.
- Keep entire body inside vehicle.
- Drive slowly in turns.
- Drive slowly, straight up and down slopes.
- Set parking brake before leaving vehicle.
- Turn main switch to "OFF" and remove key when not in use.
- Do not operate while under the influence of alcohol or drugs.

YAMAHA JN4-K7765-00

Y-502

**WARNING/AVERTISSEMENT**

<p>Gasoline is extremely flammable. Keep heat, sparks and open flame away from fuel tank and fuel lines. Do not add fuel while engine is running or hot. Do not modify fuel system. Service should be performed by dealer or qualified personnel.</p>	<p>L'essence est extrêmement inflammable. Garder éloignées, flammes et chaleur loin du réservoir à essence et des tuyaux à carburant. Ne pas ajouter d'essence pendant que le moteur est en marche ou quand le moteur est chaud. Ne pas modifier le système d'alimentation. Toute révision doit être faite chez le fournisseur ou par du personnel qualifié.</p>	<p><b>USE REGULAR UNLEADED GASOLINE ONLY</b></p> <p>Motor Oil Requirements:</p> <ul style="list-style-type: none"> <li>Use only SAE 10W-30, API service SE or SF.</li> <li>Maintain oil level between dipstick "MIN" and "MAX" marks.</li> </ul>	<p><b>UTILISER UNIQUEMENT DE L'ESSENCE SANS PLOMB</b></p> <p>Pour l'huile de moteur, il faut:</p> <ul style="list-style-type: none"> <li>Utiliser uniquement SAE 10W-30, API service SE ou SF.</li> <li>Garder le niveau d'huile entre les marques "MIN" et "MAX" indiquées sur la jauge de niveau d'huile.</li> </ul>
-------------------------------------------------------------------------------------------------------------------------------------------------------------------------------------------------------------------------------------------------------	------------------------------------------------------------------------------------------------------------------------------------------------------------------------------------------------------------------------------------------------------------------------------------------------------------------------------------------------------------------	--------------------------------------------------------------------------------------------------------------------------------------------------------------------------------------------------------------------------------------------------	------------------------------------------------------------------------------------------------------------------------------------------------------------------------------------------------------------------------------------------------------------------------------------------------------------------------

YAMAHA JN4-K6397-10

**WARNING/AVERTISSEMENT**

Do not tamper with governor to increase speed. Operation at higher speeds can cause loss of control that can result in severe injury or death.

Ne pas toucher au régulateur afin d'augmenter la vitesse. Un fonctionnement à des vitesses supérieures au régime initial peut causer une perte de contrôle qui peut mener à une blessure grave, voire fatale.

YAMAHA JJKK269-10

Y-764

G16A/E

Y-767

2-1

# IMPORTANT LABELS

2

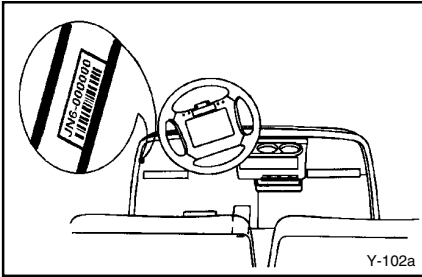

## GOLF CAR SERIAL NUMBER

The golf car serial number is stamped in the location shown.

### NOTE:

The first three digits of the serial number are for model identification; the remaining digits are the unit production number. Keep a record of these numbers for reference when ordering parts from a Yamaha dealer.

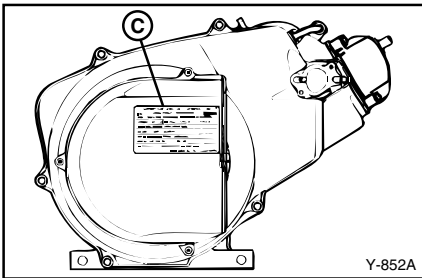

## © Engine Information

IMPORTANT ENGINE INFORMATION				YAMAHA
ENGINE FAMILY : *****				
REFER TO OWNER'S MANUAL FOR MAINTENANCE SPECIFICATIONS AND ADJUSTMENTS.				
DISPLACEMENT:	*** cm <sup>3</sup>	VALVE LASH(mm)	IN: **..**	EK: **..**
IGNITION TIMING & IDLE MIXTURE		NO OTHER ADJUSTMENTS NEEDED.		
IDLE SPEED:	**** rpm	AT NO LOAD		
FUEL: THIS ENGINE IS CERTIFIED TO OPERATE ON UNLEADED GASOLINE.				
ENGINE OIL:	SAE 10W-30	TYPE	SD	
<small>THIS ENGINE MEETS 2000-2001 CALIFORNIA EMISSION REGULATIONS FOR OFF-ROAD ENGINES.            THIS ENGINE CONFORMS TO U.S. EPA REGULATIONS FOR SMALL HORSEPOWER ENGINES.</small>				
YAMAHA MOTOR CO., LTD. JRS-2179R-04				

Y-851



# OPERATOR SAFETY

Yamaha golf cars are designed to be simple to operate. However, be sure to observe the following:

## BEFORE OPERATING THE GOLF CAR



- Read this Owner's/Operator's manual and all safety and instruction labels on the golf car before operating.
- Perform the pre-operation checks found in Section 6 of this manual.
- Only authorized people should drive the golf car, from the driver's side only, and only in designated areas.
- Do not allow more than two people to ride in the golf car. This golf car is restricted to two occupants.



- Do not operate the golf car while under the influence of alcohol or drugs; their affect on vision and judgment make operating a golf car dangerous.
- Do not operate the golf car on public streets, roads or highways. Such use is prohibited by law, and dangerous. Operation on public roads can result in collision with other vehicles.

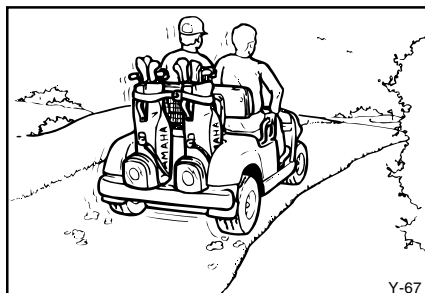

## WHILE OPERATING THE GOLF CAR

- Keep your entire body inside the golf car, remain seated, and hold on when the car is in motion.
- Do not start the golf car until all occupants are seated.



## OPERATOR SAFETY

3

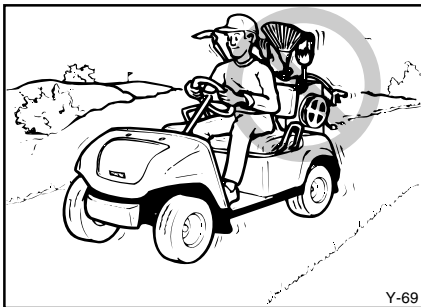
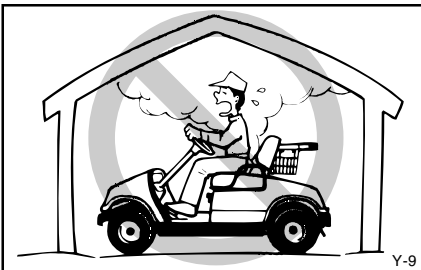
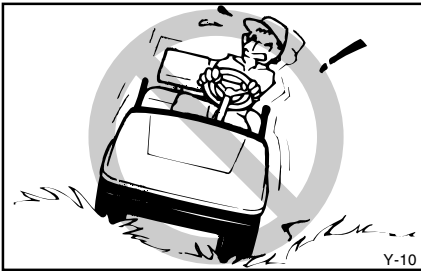

- Keep your hands on the steering wheel and your eyes on the path ahead.
- Use extra care in congested areas or when backing up. Always back up slowly, and watch carefully.
- Avoid starting or stopping abruptly.
- Vary the speed of the golf car to match the terrain of the course.
- Avoid turning the steering wheel too sharply at higher speeds.
- Always drive slowly straight up or straight down slopes – never at an angle.
- Do not run the engine indoors (G16A). Exhaust gas is poisonous.
- Do not make any modification or addition which affects capacity or safe operation, or make any changes not in accordance with the owner's/operator's manual.



# MAINTENANCE SAFETY PROGRAM

Like all machines, golf cars can cause injury if improperly used or maintained. This section contains broad safety practices required for safe golf car operation. Before golf cars are operated, golf course personnel should establish any additional safety practices that may be required for safe operation.

Experience has shown that golf cars are safe when operated in accordance with the safety warnings affixed to every golf car. This safe operation is enhanced when golf cars are used according to the safety rules and practices established to meet the terrain and conditions of the course they are used on.

The information contained here is intended for golf course personnel responsible for golf car safety. If you are responsible for the operation and maintenance of this golf car, we encourage you to implement this golf car safety program.

## DRIVER QUALIFICATIONS

Allow only authorized people to operate golf cars. It is recommended that only people who possess a valid motor vehicle driver's license be allowed to operate golf cars.

Place operation and safety instructions recommended by the golf car manufacturer, along with the golf course safety rules, in a conspicuous place near the golf car rental area or golf car pick-up area. It is also recommended that the following warning be posted in a conspicuous location:

**Do Not Operate Golf Cars When Under The Influence Of Alcohol Or Drugs**

## GOLF COURSE SAFETY SURVEY

Perform safety surveys regularly to identify hazardous areas where golf cars should not be operated.

## GOLF COURSE HAZARD PREVENTION

The following golf course hazards must be made safe:

- **Steep Grades.** Where steep grades exist, restrict golf cars to designated golf car pathways where possible. In addition, identify steep grades with a suitable warning like:

**Warning: Steep Grade, Descend Slowly With Foot On Brake**

- **Sharp Turns, Blind Corners, Bridge Approaches.** Chain or rope off these potentially hazardous areas or identify them with a suitable warning describing the nature of the hazard and the proper precautions to be taken to avoid the hazard.
- **Wet Areas.** Wet grass may cause a golf car to lose traction and may affect stability. Chain or rope off wet areas or identify wet areas with a suitable warning.



## MAINTENANCE SAFETY PROGRAM

- **Loose Terrain.** Loose terrain may cause a golf car to lose traction and may affect stability. Repair loose terrain, chain or rope off these areas, or identify loose terrain with a suitable warning.
- **Golf Car and Pedestrian Interference.** Reroute golf car traffic or pedestrian traffic in congested areas wherever possible to prevent accidents. If it is impractical to reroute traffic, erect warning signs to warn pedestrians of golf car traffic, and to warn golf car operators to drive slowly, use caution, and watch for pedestrians.
- **Ventilation.** Properly ventilate all maintenance and storage areas in accordance with applicable fire codes and ordinances to avoid fire hazards. Ventilation is required to remove flammable vapors and fumes from gasoline powered car storage areas. Ventilation is also required to remove hydrogen gas from electric powered car storage areas during the charging process.

For electric powered golf cars, the amount of hydrogen gas emitted during charging depends on a number of factors, such as the condition of the batteries, the output rate of the battery charger, and the amount of time the batteries are on charge. Because of the highly volatile nature of hydrogen gas and its propensity to rise and accumulate at the ceiling in pockets, a minimum of 5 air changes per hour is recommended. Consult applicable fire and safety codes for the specific ventilation levels requirement, as well as requirements for the use of explosion proof electrical apparatus.

4

### MAINTENANCE REQUIRED FOR GOLF CAR SAFETY

Practice the following to help ensure the safety of golf car operators:

- **Preventative Maintenance.** Perform all scheduled maintenance in accordance with manufacturer's recommendations to provide the golfing patron with a safe, properly operating golf car.
- **Personnel.** Allow only qualified, trained, and authorized personnel to inspect, adjust, and maintain golf cars.
- **Parts and Materials.** Use only replacement parts and materials recommended by the manufacturer.



# MAINTENANCE SAFETY PROGRAM

## SAFETY PRECAUTIONS DURING MAINTENANCE

When performing maintenance, follow all safety instructions contained in the manufacturer's operation and service manuals, as well as the following safety procedures:

- Properly immobilize golf car before beginning any maintenance.
- Properly block chassis before working underneath golf car.
- Before disconnecting any part of the fuel system, drain the applicable part of the system to prevent fuel leaks.
- Avoid fire hazards, and have appropriate fire protection equipment available.
- Before working on an electric golf car, disable the car's electrical system in accordance with the manufacturer's instructions.
- Use only properly insulated tools when working on electrically powered golf cars or around batteries.
- Maintain all safety devices including brakes, steering mechanisms, warning devices, and governors, in a safe operating condition. Do not modify these safety devices as supplied by the manufacturer.
- After each maintenance or repair, the car must be driven by a qualified, trained, and authorized person – in an area free of pedestrian traffic – to ensure proper operation and adjustment.

- Record all maintenance performed in a maintenance record log by date, name of person performing maintenance, and type of maintenance. Periodically inspect maintenance log to ensure accurate and complete entries.
- Provide operator comment cards to assist in identifying non-periodic maintenance needs for specific golf cars.
- Maintain in a legible condition all nameplates, warnings, and instructions provided by the manufacturer.
- If new nameplates, warnings, or instructions are needed, contact your Yamaha dealer.

## FUEL HANDLING/ STORAGE AND BATTERY CHARGING

Take the following precautions to ensure maintenance worker safety:

- Supervise the storage and handling of liquid fuels in accordance with applicable fire and safety requirements.
- Only use battery changing and charging facilities and procedures that are in accordance with applicable ordinances and regulations.
- Periodically inspect fueling and charging facilities and procedures to be certain that applicable safety codes, regulations, and procedures are being followed.

# CONTROLS

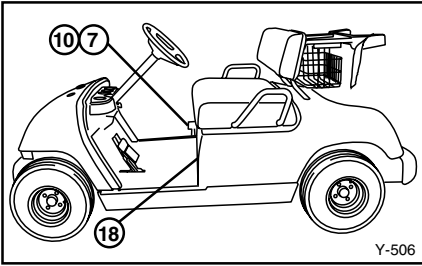

## FEATURES

- ① Steering wheel
- ② Seat
- ③ Fuel cap (for G16A)
- ④ Brake pedal
- ⑤ Parking brake pedal
- ⑥ Accelerator pedal
- ⑦ Drive selector lever
- ⑧ Main switch
- ⑨ Oil warning light (for G16A)
- ⑩ Choke knob (for G16A)
- ⑪ Front cowl
- ⑫ Front tire
- ⑬ Front bumper
- ⑭ Rear cowl
- ⑮ Rear bumper
- ⑯ Rear tire
- ⑰ Battery (for G16A)
- ⑱ Receptacle (for G16E)

5

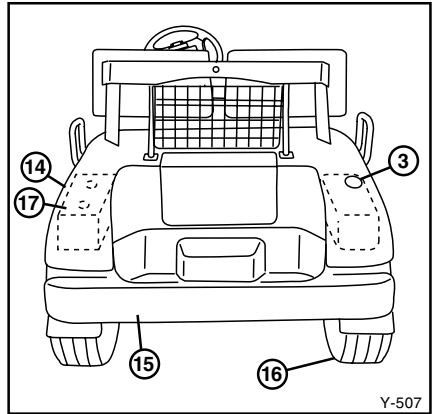
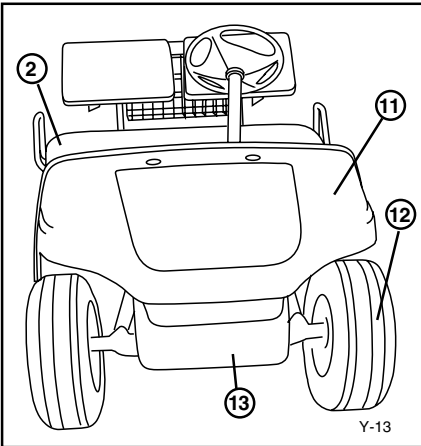
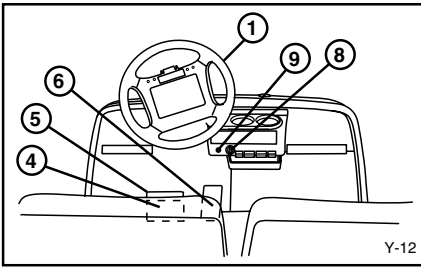

# CONTROLS

## MAIN SWITCH

The main switch controls the following items:

### OFF

Ignition circuit is switched off.

The key can be removed only in this position.

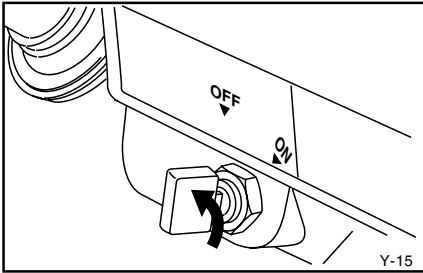

### ON

Electrical circuits are switched on.

The golf car can be driven.

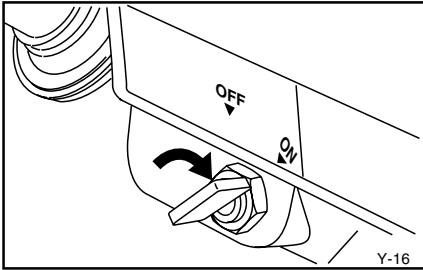

## OIL WARNING LIGHT (G16A)

When the engine oil level falls below an acceptable level, this light comes on. **If the light comes on, stop the engine, check the engine oil level, and add oil as necessary. (See page 6-3).**

Ⓐ Oil warning light

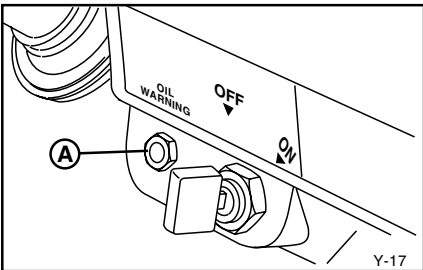

# CONTROLS

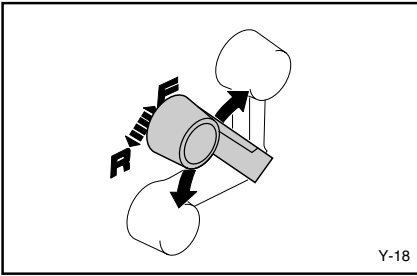

Y-18

## DRIVE SELECT LEVER

The drive select lever is used to shift the golf car into forward or reverse. After coming to a complete stop, move the lever to the desired position.

Lever Position	Car Movement
F	FORWARD
R	REVERSE

### NOTE: \_\_\_\_\_

The back-up buzzer will beep when the drive select lever is turned to "R."

5

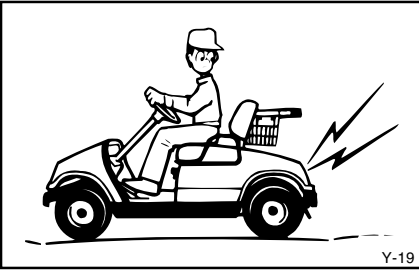

Y-19

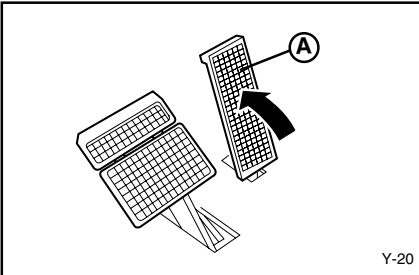

Y-20

## ACCELERATOR PEDAL

The accelerator pedal controls the golf car's speed.

Action	Car Speed
Depress pedal	Increase
Release pedal	Decrease

(A) Accelerator pedal

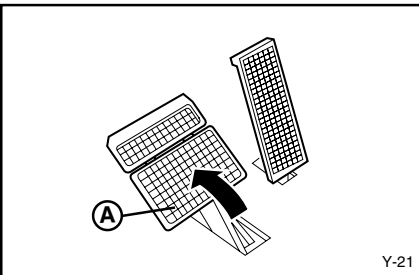

Y-21

## BRAKE PEDAL

Press down on the brake pedal to stop the golf car.

(A) Brake pedal

# CONTROLS

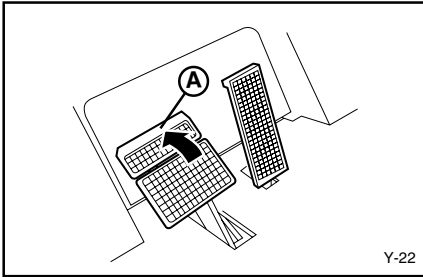

## PARKING BRAKE PEDAL

Press down on the parking brake pedal whenever parking the golf car.

- Ⓐ Parking brake pedal

### NOTE:

Release the parking brake by depressing the accelerator pedal.

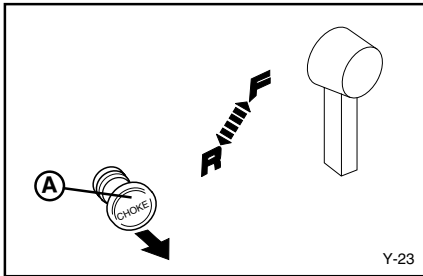

## CHOKE KNOB (G16A)

Pull and hold out choke knob when starting a cold engine. Release the knob after the engine starts.

- Ⓐ Choke knob

# PRE-OPERATION CHECKS

Pre-operation checks should be made each time you use your golf car. Get in the habit of performing the following checks in the same way so that they become second nature.

## **⚠ WARNING**

- Be sure the main switch key is removed before performing the pre-operation checks to prevent accidental starting, and apply the parking brake to keep the car from moving.
- For the G16A: During the pre-operation checks, avoid touching engine parts or the muffler while they are still hot.

## PRE-OPERATION CHECKLIST

Before each use check the following:

- ✓ Fuel system (G16A)
- ✓ Engine oil level (G16A)
- ✓ Battery
- ✓ Tire condition
- ✓ Steering system
- ✓ Back-up buzzer
- ✓ Pedal operation
- ✓ Body and chassis

## SEAT

Open the seat for checking and servicing.

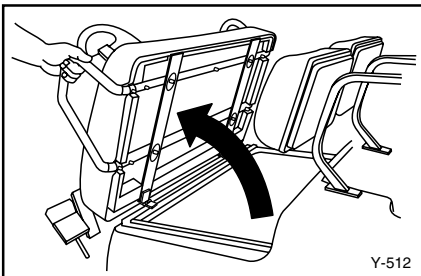

Y-512

# PRE-OPERATION CHECKS

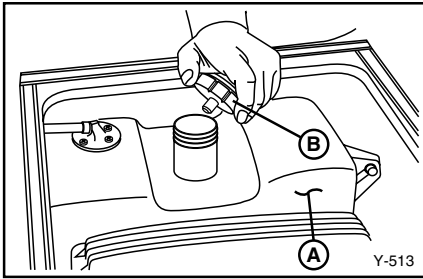

## FUEL SYSTEM (G16A)

Make sure there is sufficient fuel in the tank, and check fuel line and connections for leakage.

- Ⓐ Fuel tank
- Ⓑ Fuel cap

### **⚠ WARNING**

Gasoline and its vapors are highly flammable and explosive.

- Do not smoke when refueling and keep away from sparks, flames, or other sources of ignition.
- Stop engine and allow it to cool for several minutes before refueling.
- Refuel in a well-ventilated area.
- Take care not to spill gasoline. If gasoline spills, wipe it up immediately with dry rags. Always dispose of gasoline-soaked rags properly.
- Tighten the filler cap securely after refueling.
- If you swallow gasoline, inhale a lot of gasoline vapor, or get gasoline in your eyes, get immediate medical attention.
- If any gasoline gets on your skin, immediately wash with soap and water. Change clothing if gasoline spills on it.

6

Recommended fuel:  
Unleaded gasoline

Fuel tank capacity:  
6.3 US gal  
(24.0 L, 5.3 Imp gal)

### **CAUTION**

Avoid using gasoline blended with methyl alcohol which can damage fuel system parts.

# PRE-OPERATION CHECKS

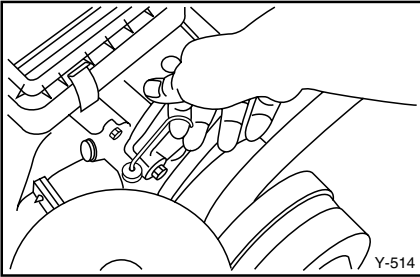

## ENGINE OIL (G16A)

With the golf car parked on level ground, remove the dipstick and make sure the engine oil is between the MIN and MAX marks (the cross-hatched area on the end of the dipstick).

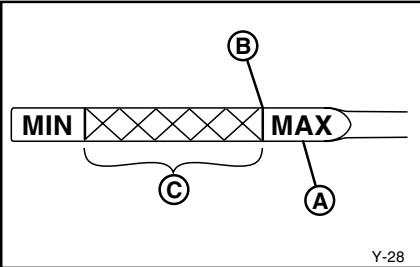

- (A) Oil level dipstick
- (B) Maximum oil level
- (C) Safe operating range

If the oil level is **below** the MIN mark on the dipstick, add oil through the oil filler hole until the oil level is between the MIN and MAX marks.

6

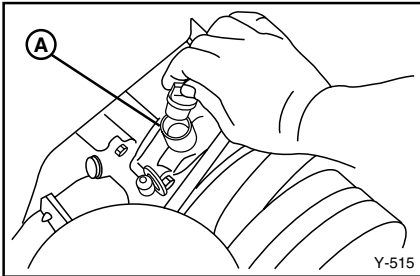

- (A) Oil filler hole

### CAUTION

- Use care not to fill past the MAX dipstick mark, and be sure no foreign material enters the crankcase.
- Use care not to get oil on the starter belt.

Recommended oil:  
YAMALUBE 4-cycle oil or  
SAE 10W-30

Engine oil capacity:  
1.16 US qt  
(1.0 L, 0.24 Imp gal)

Oil change quantity:  
1.0 US qt  
(0.9 L, 0.19 Imp gal)

**NOTE:** \_\_\_\_\_  
The distance between the dipstick marks represents approx. 1/2 US qt (1/2 L) of oil.

**NOTE:** \_\_\_\_\_  
Recommended engine oil classification: API Service SE, SF, or SG. Engine oils labeled "Energy Conserving II" are recommended.

# PRE-OPERATION CHECKS

## Engine Cooling Inlet Duct

Check the engine cooling inlet duct for debris. Remove any debris present.

Ⓐ Engine cooling inlet duct

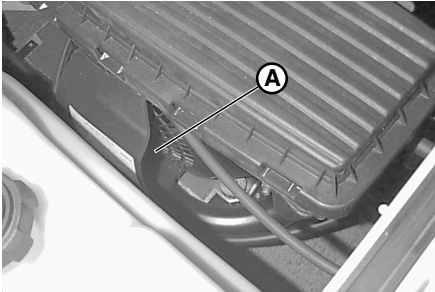

G16A1

## BATTERY

Charge G16E batteries before each use. See charging steps in chapter 8, *Maintenance*.

Check that the battery (G16A) or batteries (G16E) are held securely in place to prevent the batteries from being damaged from vibration or jarring. Also check that no battery caps are missing to prevent battery acid from spilling from the battery. Check the battery terminals for corrosion.

6

## TIRE CONDITION

### Tire Air Pressure

Check the tire air pressure before operating the golf car.

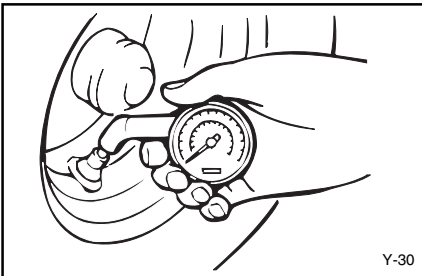

Y-30

Tire pressure:

For G16A: 16 psi  
(108 kPa, 1.1 kgf/cm<sup>2</sup>)

For G16E: 20 psi  
(137 kPa, 1.4 kgf/cm<sup>2</sup>)

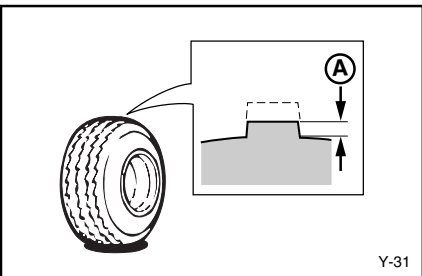

Y-31

### Tire Wear Limit

Check the tire surface for damage, cracks or embedded objects. When tire tread wears down to 0.04 in. (1 mm), replace the tire.

Ⓐ Wear limit

# PRE-OPERATION CHECKS

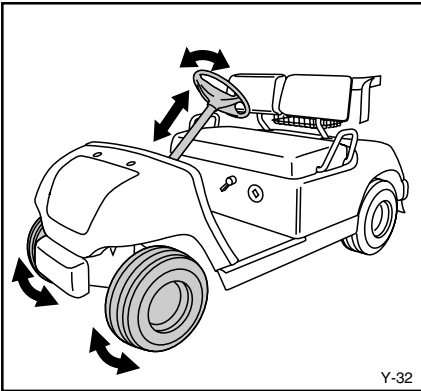

## STEERING SYSTEM

Check the steering system for excessive freeplay by:

- moving the steering wheel up and down, and back and forth.
- turning the steering wheel slightly to the right and left.

If you feel excessive freeplay, or hear rattling sounds which may indicate loose steering components, consult a Yamaha dealer.

6

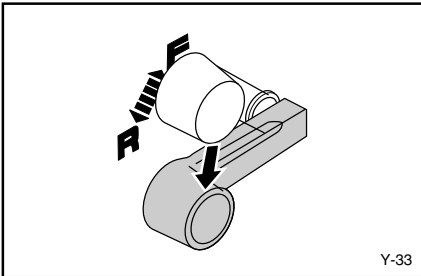

## BACK-UP BUZZER

Check the back up buzzer by moving the drive select lever to "R" for reverse. The buzzer should sound.

## PEDAL OPERATION

Check the following pedal controls for proper operation. If a pedal does not work properly, consult a Yamaha dealer.

### Brake Pedal

Make sure the brake pedal feels firm when pressed and returns to its original position when released.

- Ⓐ Brake pedal

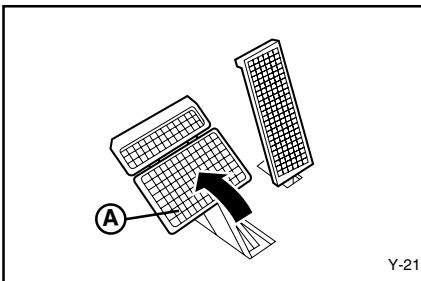

# PRE-OPERATION CHECKS

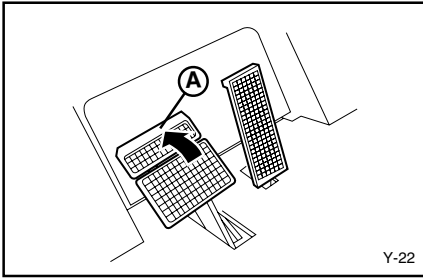

## Parking Brake Pedal

Make sure the parking brake pedal locks in place with a positive click, and releases when the accelerator pedal is pressed.

Ⓐ Parking brake pedal

**NOTE:** \_\_\_\_\_

Release the parking brake by depressing the accelerator pedal.

---

## Accelerator Pedal

**⚠ WARNING** \_\_\_\_\_

**Before checking operation of the accelerator pedal, be sure the main switch is in the "OFF" position.**

---

Make sure the accelerator pedal operates smoothly.

Ⓐ Accelerator pedal

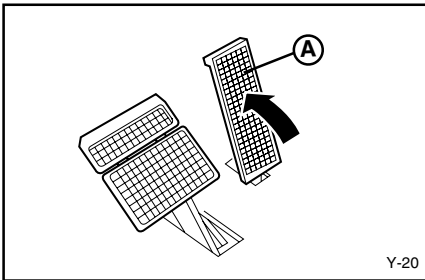

## BODY AND CHASSIS

Before each use, visually inspect the golf car body and chassis for damage and/or missing parts.

# OPERATION

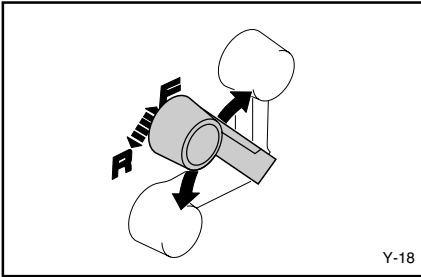

## STARTING

1. With the parking brake applied, turn the drive select lever to “F” for forward, or “R” for reverse.

### CAUTION

Do not shift from “F” forward to “R” reverse while the golf car is moving.

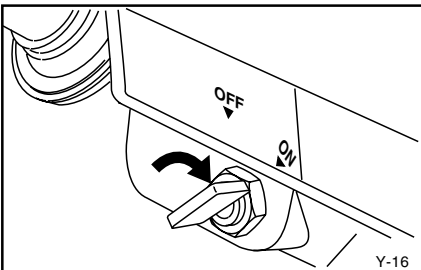

2. Turn the main switch to “ON.”

### WARNING

Do not depress the accelerator pedal when turning on the main switch or the golf car may suddenly start moving.

7

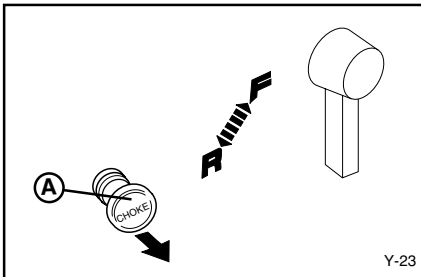

3. Pull the choke knob out and hold it while starting (G16A). Release the choke knob after the engine starts.

(A) Choke knob

### NOTE:

The choke is not required when the engine is warm.

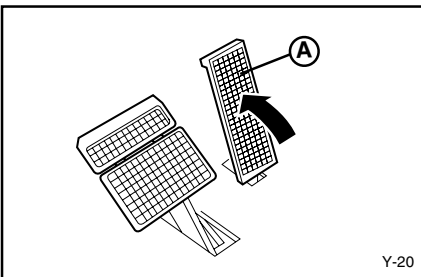

4. Check that your path is clear in the direction you plan to go, and slowly depress the accelerator pedal. The golf car will start to move.

(A) Accelerator pedal

### NOTE:

The parking brake automatically releases when the accelerator pedal is depressed.

## STOPPING

To stop the golf car, gradually press down on the brake pedal.

(A) Brake pedal

When the car has come to a stop, apply the parking brake pedal and turn the main switch to "OFF."

(B) Parking brake pedal

### CAUTION

**Do not hold the golf car on an incline with the accelerator – use the brake.**

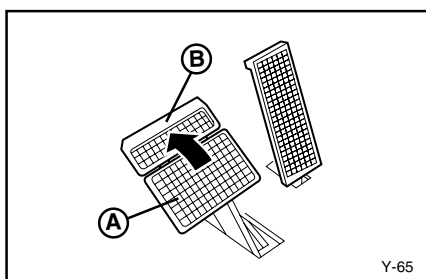

## TROUBLESHOOTING G16A

If G16A's gas engine won't start, use the following chart:

Cause	Remedy
Fuel System	
No fuel in tank	Fill fuel tank
Clogged fuel line	Clean fuel line – Consult Yamaha dealer
Foreign matter in fuel filter	Clean fuel filter – Consult Yamaha dealer
Clogged carburetor	Clean carburetor – Consult Yamaha dealer
Electrical System	
Spark plug dirty with carbon, or wet	Clean carbon or wipe spark plug dry
Faulty ignition system	Consult Yamaha dealer

# MAINTENANCE

## PERIODIC MAINTENANCE CHARTS

Regular maintenance is required for the best performance and safe operation of your golf car.

### WARNING

Be sure to turn off the main switch and apply the parking brake when you perform maintenance unless otherwise specified. If the owner is not familiar with machine servicing, this work should be done by a Yamaha dealer or other qualified mechanic.

#### FOR G16A

C - CHECK CA - CHECK AND ADJUST R - REPLACE S - SERVICE CL - CLEAN AND LUBRICATE L - LUBRICATE

	Remarks	Pre-Operation	20 Rounds 20 hours 100 miles 160 kms (Every month)	125 rds 125 hrs 600 mls 1000 kms (Every 6 months)	250 rds 250 hrs 1200 mls 2000 kms (Every year)	500 rds 500 hrs 2500 mls 4000 kms (Every 2 years)	1000 rds 1000 hrs 5000mls 8000 kms (Every 4 years)	Page
PRE-OPERATION CHECKS	Check engine oil	C	C	C				6-3
	Check air cooling duct	C	C	C	C	C	C	*
	Check fuel lines for leakage	C	C	C	C	C	C	6-2
	Check fuel level	C	C	C	C	C	C	6-2
	Check for looseness and corrosion of battery terminals and hold downs	C	C	C	C	C	C	6-4
	Check brake pedal freeplay and adjust if necessary	C	CA	CA	CA	CA	CA	8-18
	Check steering operation	C	C	C	C	C		6-5
	Check tire pressure, tread depth, tire surface for damage	C	CA	CA	CA	CA	CA	6-4
	Check body and chassis for damage	C	C	C	C	C	C	6-6
	Check tightness of all bolts, nuts, and screws	C	C	C	C	C	C	*
Check reverse buzzer operation	C	C	C	C	C	C	6-5	
EVERY MONTH	Check fuel filter for clogging		C	C	C	C	C	*
	Check wear of drive belt		C	C	C	C	C	8-9
	Check operation of Forward / Reverse shifting		C	C	C	C	C	—
	Clean / Lube pedal control area		CL					—
EVERY 6 MONTHS	Wash pre-filter, check air cleaner element			S	S	S	S	8-7
	Check spark plug and plug cap condition** / Check compression			C	C	C	C	8-5/*
	Check shock absorbers for oil leaks and damaged springs			C	C	C		*

\* Items with out a page number reference should be serviced by a Yamaha dealer or other qualified mechanic. This manual does not contain these procedures. They are contained in the Service Manual.

\*\*Related to emission control system.

# MAINTENANCE

## FOR G16A (continued)

C - CHECK CA - CHECK AND ADJUST R - REPLACE S - SERVICE CL - CLEAN AND LUBRICATE L - LUBRICATE

	Remarks	Pre-Operation	20 Rounds 20 hours 100 miles 160 kms (Every month)	125 rds 125 hrs 600 mls 1000 kms (Every 6 months)	250 rds 250 hrs 1200 mls 2000 kms (Every year)	500 rds 500 hrs 2500 mls 4000 kms (Every 2 years)	1000 rds 1000 hrs 5000mls 8000 kms (Every 4 years)	Page
EVERY YEAR	Replace engine oil				R	R	R	8-6
	Adjust throttle cables,** choke cable, check carburetor throttle shaft for wear**				CA	CA	CA	*
	Check starter V-belt for damage and tension				C	C	C	*
	Check drive belt for slippage, wear or scratches				C	C	C	8-8
	Check sliding sheave and ramp shoes; Grease secondary sheave bearing.				CL	CL	CL	*
	Grease primary sheave				L	L	L	*
	Check operation of speed limiter				C	C	C	*
	Apply battery terminal protectant				S	S	S	—
	Check wiring connections and insulation				C	C	C	—
	Check shoe lining thickness and rear axle bearing play				C	C	C	*
	Check kingpin play, seal, and cap / Adjust wheel alignment				CA	CA	CA	*
	Check wheel nut tightness, front wheel bearing play				C	C	C	*
	Check gear box oil level and leakage				C	C	C	8-16
	Check operation and adjust pedal stop if necessary				CA	CA	CA	*
EVERY 2 YEARS	Check brushes for wear and commutator for dirt					C	S	*
EVERY 4 YEARS	Replace fuel filter and fuel hoses						R	*
	Check tightness of cylinder head / Adjust valves						CA	*
	Replace gear box oil						R	*
	Check for grease leakage; adjust gearbox if necessary						CA	*

\* Items with out a page number reference should be serviced by a Yamaha dealer or other qualified mechanic. This manual does not contain these procedures. They are contained in the Service Manual.

\*\*Related to emission control system.

# MAINTENANCE

FOR 16E

C - CHECK CA - CHECK AND ADJUST R - REPLACE S - SERVICE CL - CLEAN AND LUBRICATE L - LUBRICATE

	Remarks	Pre-Operation	20 rounds 20 hours 100 miles 160 kms (Every Month)	125 rds 125 hrs 600 mls 1000 kms (Every 6 months)	250 rds 250 hrs 1200 mls 2000 kms (Every Year)	500 rds 500 hrs 2500 mls 4000 kms (Every 2 years)	1000 rds 1000 hrs 5000 mls 8000 kms (Every 4 years)	Page
PRE-OP	Charge	S	S	S	S	S	S	8-13
	Clean battery tops, check for tightness of hold-down screws and terminals	S	S	S	S	S	S	8-11
	Check brake pedal freeplay and adjust if necessary	C	CA	CA	CA	CA	CA	8-18
	Check steering operation	C	C	C	C	C	C	6-5
	Check tire pressure, tread depth, tire surface for damage	C	CA	CA	CA	CA	CA	6-4
	Check body and chassis for damage	C	C	C	C	C	C	6-6
	Check tightness of all bolts, nuts, and screws	C	C	C	C	C	C	*
	Check reverse buzzer operation	C	C	C	C	C	C	6-5
EVERY MONTH	Check electrolyte level		C	C	C	C	C	8-12
	Check for loose or broken connections		C	C	C	C	C	*
	Clean/Lube pedal control area		CL					
EVERY 6 MONTHS	Check all wire insulation for cracks and/or worn spots			C	C	C	C	*
	Check shock absorbers for oil leaks and damaged springs			C	C	C	C	*
EVERY YEAR	Perform a discharge test				S	S	S	*
	Apply Terminal protectant				S	S	S	
	Check shoe lining thickness and rear axle bearing play				C	C	C	*
	Check kingpin play, seal, and cap / Adjust wheel alignment				CA	CA	CA	*
	Check wheel nut tightness, front wheel bearing play				C	C	C	*
	Check gear box oil level and leakage				C	C	C	8-16
	Check operation and adjust pedal stop if necessary				CA	CA	CA	*
EVERY 4 YEARS	Replace gear box oil						R	*
	Check for grease leakage; adjust gear box if necessary						CA	*

\* Items without a page number reference should be serviced by a Yamaha dealer or other qualified mechanic. This manual does not contain these procedures. They are contained in the Service Manual.

# MAINTENANCE

## EXHAUST EMISSION CONTROL SYSTEM AND COMPONENTS

Item	Acronym
<ul style="list-style-type: none"><li>CARB. ASSY., LH., JT., CARBURETOR 2 &amp; JT., CARBURETOR 1</li></ul>	CARB (Carburetor)
<ul style="list-style-type: none"><li>T.C.I. MAGNETO ASSY. &amp; PLUG, SPARK</li></ul>	EI (Electronic Ignition)
<ul style="list-style-type: none"><li>CRANKCASE 1 &amp; HEAD, CYLINDER 1</li></ul>	PCV (Positive Crankcase Ventilation)
<ul style="list-style-type: none"><li>AIR FILTER ASSY.</li></ul>	ACL (Air Cleaner)
<ul style="list-style-type: none"><li>MUFF., 2</li></ul>	

The above items and the corresponding acronyms are provided in accordance with U.S. EPA REGULATIONS FOR SMALL NONROAD ENGINES and the CALIFORNIA REGULATIONS FOR NEW 1995 AND LATER OFF-HIGHWAY RECREATIONAL VEHICLES AND ENGINES.

The acronyms conform to the latest version of the SAE's recommended practice document J1930, "Diagnostic Acronyms, Terms, and Definitions For Electrical/Electronic System".

It is recommended that these items be serviced by a Yamaha dealer or other qualified mechanic.

# MAINTENANCE - G16A

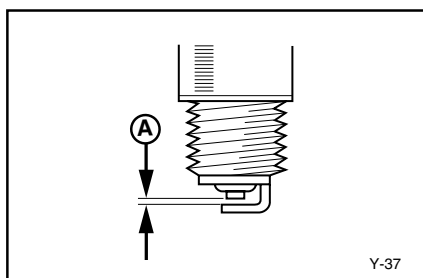
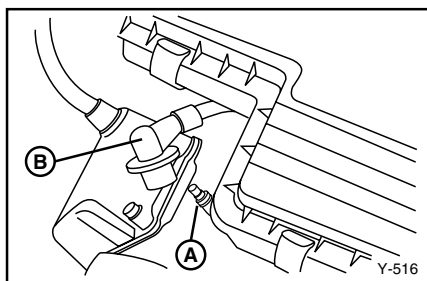

## Spark Plug Inspection

You should periodically remove and inspect the spark plug. Dirty or worn spark plugs can cause poor performance.

- (A) Spark plug
- (B) Spark plug cap

1. Check for discoloration and remove carbon deposits with a spark plug cleaner or wire brush. The normal electrode color will be tan.
2. Check the spark plug type, and check the spark plug gap with a feeler gauge.

Standard spark plug:  
BPR2ES

Spark plug gap:  
0.028 ~ 0.031 in (0.7 ~ 0.8 mm)

- (A) Gap
3. Clean the gasket and plug surfaces and install the spark plug finger tight before tightening to the following torque:

Spark plug torque:  
14.5 ft·lb  
(20 Nm, 2.0 m·kg)

### **⚠ WARNING**

When removing or installing the spark plug, be careful not to damage the insulator. A damaged insulator could allow external sparks, which could lead to explosion or fire.

# MAINTENANCE - G16A

## Engine Oil Replacement

1. Warm up the engine for several minutes, place the golf car on a level surface, then stop the engine.

### **⚠ WARNING**

**Use caution not to touch hot engine oil or hot engine parts, during the following procedure.**

2. Place an oil pan under the engine drain plug.
3. Remove the oil drain plug and let the oil drain completely.

### **NOTE:**

Dispose of used oil in an environmentally safe way, such as taking oil to an oil collection station.

4. Install the drain plug, along with a new drain plug gasket, finger tight before tightening to the following torque:

Drain plug torque:  
23 ft·lb  
(31 Nm, 3.1 m·kg)

5. Add the correct quantity of oil through the oil filler hole.

### **NOTE:**

Recommended engine oil classification: API Service SE, SF, or SG. Engine oils labeled "Energy Conserving II" are recommended.

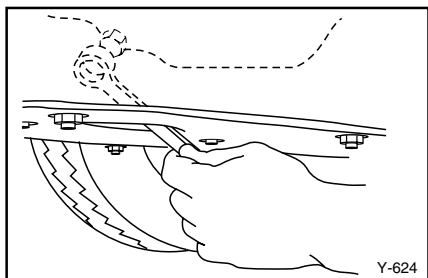

Recommended oil:  
YAMALUBE 4-cycle oil or  
SAE 10W-30

Engine oil capacity:  
1.16 US qt  
(1.0 L, 0.24 Imp gal)

Oil change quantity:  
1.0 US qt  
(0.9 L, 0.19 Imp gal)

# MAINTENANCE - G16A

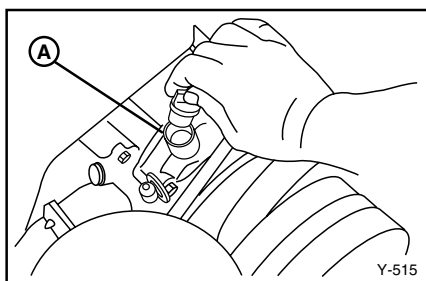

(A) Oil filler hole

## CAUTION

Use care not to fill past the MAX dipstick mark, and be sure no foreign material enters the crankcase. After replacing engine oil, check for oil leaks around the drain plug. If oil leaks are found, consult a Yamaha dealer.

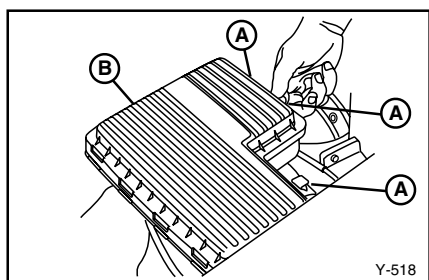

To remove the air filter elements:

1. Unlatch the air filter cover clips and remove cover.

(A) Air filter cover clips

(B) Air filter cover

2. Lift the air filter and pre-filter out of the air filter case.

(A) Air filter

(B) Pre-filter

## CAUTION

Be careful not to drop anything into the air inlet.

8

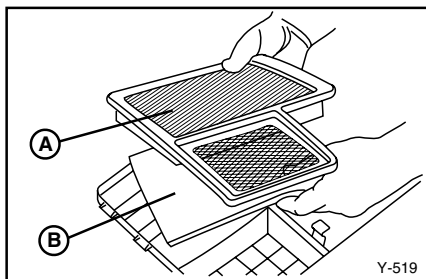

# MAINTENANCE - G16A

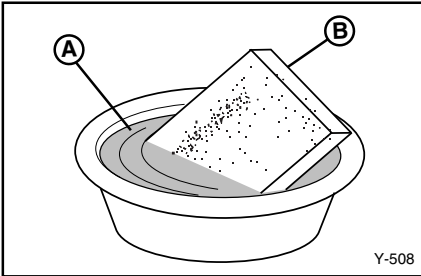

Inspection and cleaning:

3. Wash the foam pre-filter in soap and water. Allow it to dry.

- (A) Soap and water
- (B) Foam element

4. Check the filter element. If damaged or dirty, replace it.

## CAUTION

**Do not wring out the foam pre-filter, this could cause it to tear.**

5. To replace the elements, reverse the above steps.

## CAUTION

**The pre-filter has a notch on one side. It will only fit in the case one way.**

## Drive Belt

To remove the drive belt:

1. Set the drive select lever halfway between forward and reverse.
2. Pull up on the drive belt and push it outward over the edge of the secondary sheave.
3. Turn the secondary sheave clockwise and the drive belt will roll off the sheave.
4. Remove the drive belt from the primary sheave.

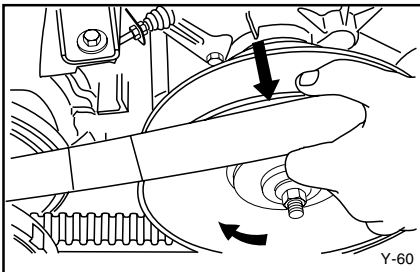

# MAINTENANCE - G16A

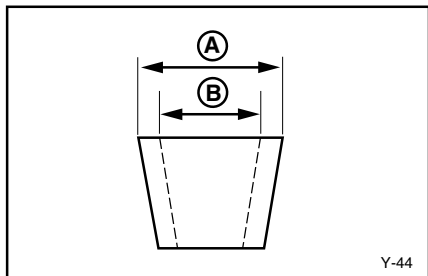

Inspection:

To inspect the drive belt, check for frayed edges or tears, and measure drive belt against the following specification. If the belt shows excessive wear or damage, replace the belt with a new one.

- Ⓐ New: 1.22 in. (31.0 mm)
- Ⓑ Replace when belt reaches: 1.06 in. (27 mm)

5. To install the drive belt, reverse the above steps, rolling the belt back over the secondary sheave.

## Battery

### **⚠ WARNING**

**Battery electrolyte is poisonous and dangerous, causing severe burns, etc. It contains sulfuric acid. Avoid contact with skin, eyes, or clothing.**

**Antidote:**

**EXTERNAL:** Flush with water.

**INTERNAL:** Drink large quantities of water or milk. Follow with milk of magnesia, beaten egg, or vegetable oil. Call physician immediately.

**EYES:** Flush with water for 15 minutes and get prompt medical attention.

**Batteries produce explosive gases. Keep sparks, flame, cigarettes, etc., away.**

**Ventilate when charging or using in enclosed space. Always shield eyes when working near batteries. KEEP OUT OF REACH OF CHILDREN.**

# MAINTENANCE - G16A

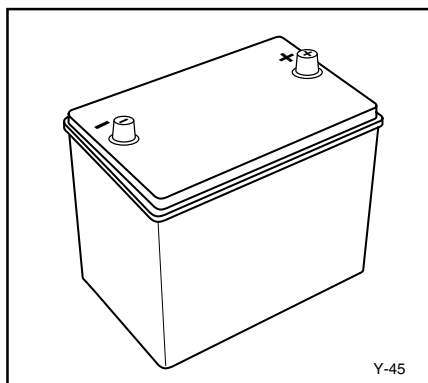

Y-45

The 12-volt battery that provides starting power to your gas car normally doesn't require the addition of water during the one year period provided by the battery manufacturer. If the battery loses its charge, have an experienced mechanic charge it.

## Fuse Replacement

### **⚠ WARNING**

Be sure to use the specified fuse. Using a wrong fuse can cause electrical system damage and create a fire hazard.

### **CAUTION**

When replacing a fuse be sure the main switch is turned off to prevent accidental short circuiting.

1. Remove cap screw on cover. Pull fuse case cover forward.

- (A) Cap screw
- (B) Fuse case cover

**NOTE:** You do not have to remove the cover.

2. Pull cap off fuse. Pull fuse out and replace if necessary.

- (C) Fuse cap
- (D) Fuse

Replacement Fuse:  
10 Amp, Blade Style

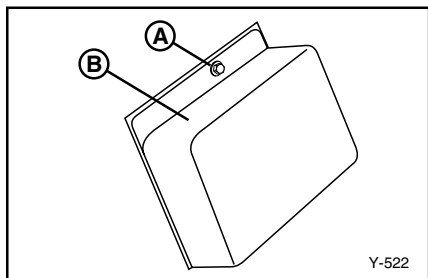

Y-522

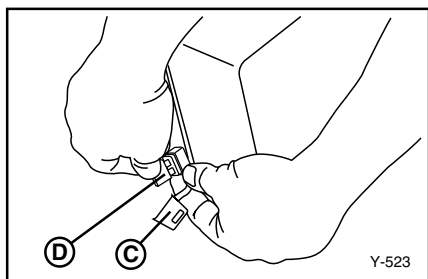

Y-523

# MAINTENANCE - G16E

## Battery Care

### **⚠ WARNING**

Battery electrolyte is poisonous and dangerous, causing severe burns, etc. It contains sulfuric acid. Avoid contact with skin, eyes, or clothing.

Antidote:

**EXTERNAL:** Flush with water.

**INTERNAL:** Drink large quantities of water or milk. Follow with milk of magnesia, beaten egg, or vegetable oil. Call physician immediately.

**EYES:** Flush with water for 15 minutes and get prompt medical attention.

Batteries produce explosive gases. Keep sparks, flame, ciga-rettes, etc., away.

Ventilate when charging or using in enclosed space. Always shield eyes when working near batteries.

**KEEP OUT OF REACH OF CHILDREN.**

Six 6-volt deep cycle batteries provide power for your electric golf car and must be properly maintained and recharged for maximum performance and service life.

To maintain your batteries:

1. Clean the tops of the batteries with a solution of baking soda and water, as necessary, to remove corrosion.

### **CAUTION**

**Do not allow cleaning solution to enter battery cells.**

2. Check the fluid level before and after charging.

# MAINTENANCE - G16E

- **Before charging:** only add distilled water if fluid is below the top of the plates, and then add just enough to cover plates.
- **After charging:** check that the fluid level is approximately 1/4 to 1/2 inch above the plates and 1/4 to 3/8 inch below the level indicator. If the fluid level is low, carefully add distilled water. Adding distilled water **after** charging prevents boil over.

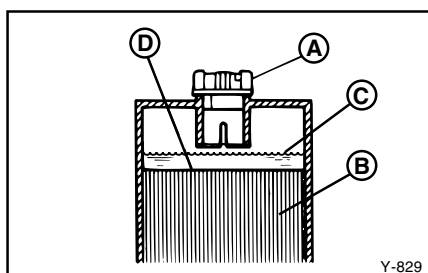

- (A) Battery cap
- (B) Plates
- (C) Maximum fluid level
- (D) Minimum fluid level

## CAUTION

**Normal tap water contains minerals which are harmful to a battery; therefore, refill only with distilled water.**

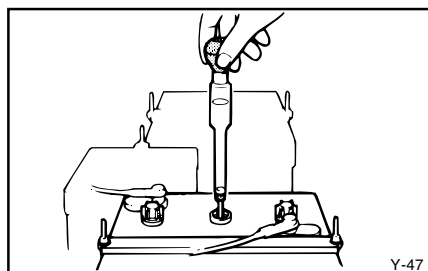

- Using a hydrometer, check the specific gravity of the battery fluid in each cell against the readings on the chart below. Consult a Yamaha dealer if any low readings are found, or if readings vary more than one point between cells.

Temperature		Satisfactory Uncorrected Hydrometer Reading
°F	°C	
120	48.9	1.244
110	43.3	1.248
100	37.8	1.252
90	32.2	1.256
80	26.7	1.260
70	21.1	1.264
60	15.6	1.268
50	10.0	1.272
40	4.4	1.276
30	-1.1	1.280

# MAINTENANCE - G16E

## Battery Charging

### **⚠ WARNING**

Read and understand the owner's manual provided with your golf car's battery charger before charging batteries.

### **⚠ WARNING**

Explosive hydrogen gas is produced while batteries are being charged. Only charge batteries in well ventilated areas (a minimum of 5 air changes per hour is recommended).

To charge the batteries in your golf car, follow the instructions contained in your battery charger's owner's manual.

The following is a summary of the charging steps. **Do not attempt to recharge your golf car's batteries without thoroughly reading and understanding the owner's manual provided with your charger.**

1. Turn main switch key to "OFF" position.
2. With the charger properly connected and grounded (see charger's owner's manual), insert the DC output plug into the golf car receptacle.
3. Monitor the ammeter on the charger according to instructions found in the charger's owner's manual.

8

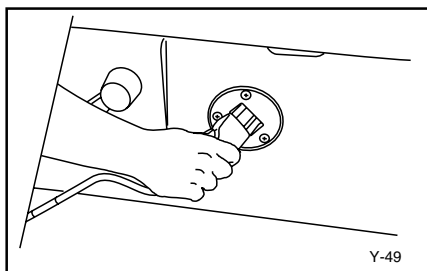
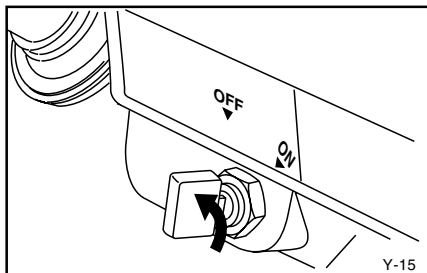

# MAINTENANCE - G16E

## **⚠ WARNING**

Do not disconnect the DC output cord from the battery receptacle when the charger is on or an arc could occur that may cause an explosion.

4. The charger will turn off automatically when the batteries reach full charge.
5. After the charger has turned off, disconnect the DC output plug from the golf car receptacle by grasping the plug body and pulling the plug straight out of the receptacle.

## Battery Installation

### **⚠ WARNING**

When working with batteries, do not put wrenches or other metal objects across the battery terminals. An arc can occur causing explosion of the battery.

1. Install the battery holddown plates as shown.

- (A) Forward
- (B) Battery
- (C) Battery fitting plate

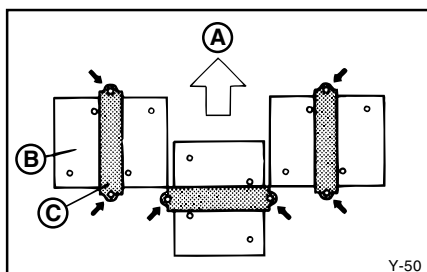

# MAINTENANCE - G16E

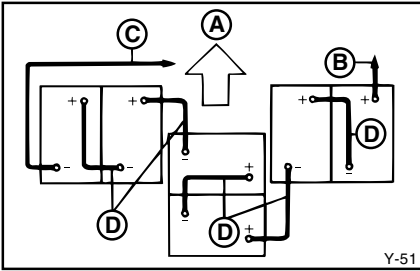

2. Connect the wire leads as shown.

- Ⓐ Forward
- Ⓑ To relay
- Ⓒ To controller
- Ⓓ Between batteries

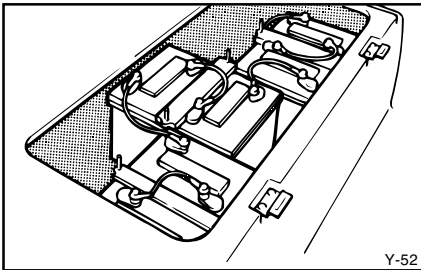

## ⚠ WARNING

When installing batteries:

- Carefully place battery cables and holddowns making sure that cables don't lie across vent caps.
- Always remove the negative (-) cable to the motor controller first, and install it last.

## CAUTION

Do not overtighten the battery holddown nuts. Excessive force will damage the battery casing.

8

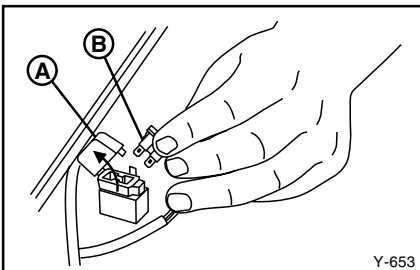

Fuse Type:  
10 Amp, Blade Style

## Fuse Replacement

### ⚠ WARNING

Be sure to use the specified fuse. Using a wrong fuse can cause electrical system damage and create a fire hazard.

## CAUTION

When replacing a fuse be sure the main switch is turned off to prevent accidental short-circuiting.

- Ⓐ Fuse case
- Ⓑ Fuse

# MAINTENANCE - G16A & G16E

## Gear Box Oil

To check gear box oil level:

1. Place the golf car on a level surface.
2. Remove the access panel by removing the screws in the two lower corners of the panel and pulling the panel from the car.

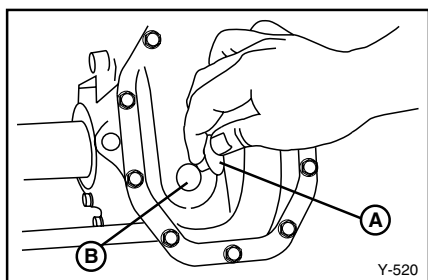
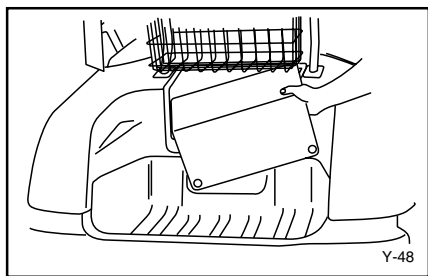

Recommended oil:  
SAE 90 gear oil

Gearcase capacity:  
G16A: 0.44 US qt  
(0.42 L, 0.09 Imp gal)

G16E: 0.32 US qt  
(0.3 L, 0.06 Imp gal)

### 3. For G16A and G16E

- Remove the oil level plug (A).
  - Add gear oil little by little until oil flows from the level plug hole (B).
4. Allow excess gear oil to flow out until it stops.

## CAUTION

**Do not allow foreign material to enter the gear box.**

5. Reinstall the oil level plug.

## NOTE:

For gear oil replacement, consult a Yamaha dealer or other qualified mechanic.

# MAINTENANCE - G16A & G16E

## Wheel Replacement

To remove and install a wheel on your golf car:

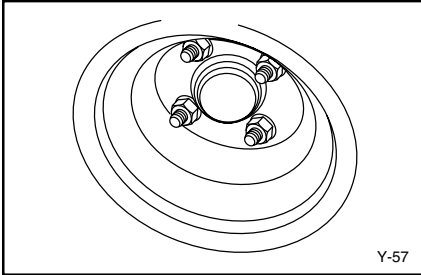

1. With the wheels blocked to prevent the golf car from moving, loosen the wheel nuts.
2. Elevate the golf car with a jack and remove the wheel nuts and the wheel.
3. Reverse the removal steps when installing the wheel.

Wheel nut tightening torque:  
58 ft·lb (80 Nm, 8.0 m·kg)

## Brake Adjustment

The brakes on your golf car are self-adjusting.

Before you operate the car, press down on the brake pedal several times to make sure the brakes are functioning properly.

### **⚠ WARNING**

**Consult your Yamaha dealer before using your golf car if you suspect brake problems. Brake failure could result in a serious accident.**

# MAINTENANCE - G16A & G16E

## Brake Pedal Free Play Adjustment

### CAUTION

Before adjusting brake pedal free play, pump the brake pedal several times to self-adjust the brakes.

To adjust the brake pedal free play:

1. Remove the service lid from the floor of the golf car.
2. Check the brake pedal free play by pressing against the pedal with two fingers (using light force) and measuring the distance the pedal travels before resistance is felt.

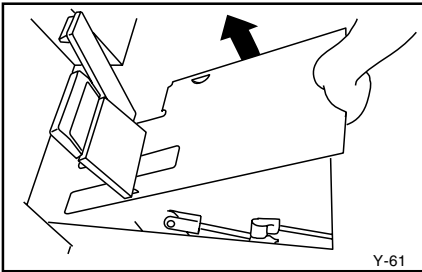

Y-61

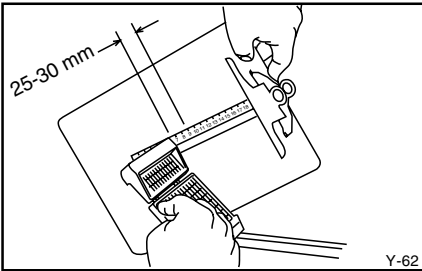

Y-62

Brake pedal free play:  
25-30 mm (0.98-1.18 in.)

3. If the free play distance needs adjusting, loosen the lock nut and turn the adjusting nut in or out until the free play specification is met. Then tighten the lock nut in place.

### ⚠ WARNING

Do not overtighten the brake cables. The self adjusters may not operate properly, reducing braking performance.

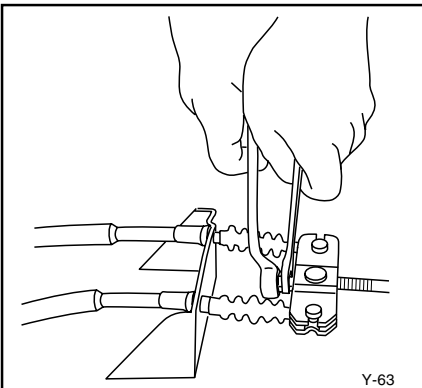

Y-63

# STORAGE

Perform the following preparations when storing your golf car for extended periods of time:

**NOTE:** \_\_\_\_\_

Turn main switch key to “OFF” position, remove key, and store key in a safe place.

---

## DRAINING FUEL (G16A GAS CAR)

**▲ WARNING** \_\_\_\_\_

Gasoline and its vapors are highly flammable and explosive.

- Do not smoke when refueling and keep away from sparks, flames, or other sources of ignition.
  - Stop engine and allow it to cool for several minutes before refueling.
  - Refuel in a well-ventilated area.
  - Take care not to spill gasoline. If gasoline spills, wipe it up immediately with dry rags. Always dispose of gasoline-soaked rags properly.
  - Tighten the filler cap securely after refueling.
  - If you swallow gasoline, inhale a lot of gasoline vapor, or get gasoline in your eyes, get immediate medical attention.
  - If any gasoline gets on your skin, immediately wash with soap and water. Change clothing if gasoline spills on it.
- 

1. Fill the fuel tank.
- Ⓐ Float bowl drain screw
2. Drain the carburetor float bowl into a suitable container by turning the screw located on the bottom of the carburetor.

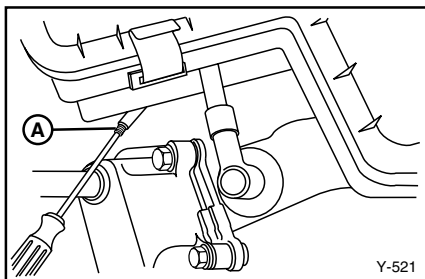

# STORAGE

## ENGINE PREPARATION (G16A GAS CAR)

With the key removed and the spark plug lead disconnected, turn the clutch by hand until compression is felt. This puts the valves in the closed position.

## CHASSIS PREPARATION

1. Increase the tire pressure to 20 psi (137 kPa, 1.4 kgf/cm<sup>2</sup>).
2. Clean exterior of the golf car and apply a rust inhibitor.
3. Cover the golf car with a breathable cover and store it in a dry, well-ventilated area.

## BATTERY PREPARATION

### For G16A:

1. Remove the battery from the golf car and store it in a cool, dry place that stays between 32°F (0°C) and 90°F (30°C).

2. Have the battery recharged every 60-90 days to keep it fully charged. The battery must be kept fully charged to avoid damage.

### NOTE: \_\_\_\_\_

Batteries like the one supplied with your car normally do not require you to check the water level inside the battery for the one year warranty period provided by the manufacturer.

### For G16E:

1. Clean the tops of the batteries with a solution of baking soda and water, as necessary, to remove corrosion.

### CAUTION \_\_\_\_\_

**Do not allow cleaning solution to enter battery cells.**

2. Recharge the batteries and check the fluid levels at least once a month.

# SPECIFICATIONS

## GENERAL SPECIFICATIONS

Items	G16A	G16E
Dimensions:		
Overall length	93.9 in. (2385 mm)	
Overall width	47.2 in. (1200 mm)	
Overall height (steering height)	46.8 in. (1190 mm)	
Height of floor	11.8 in. (300 mm)	
Wheelbase	64.0 in. (1629 mm)	
Tread:		
Front	34.3 in. (870 mm)	
Rear	38.6 in. (980 mm)	
Min. ground clearance	3.8 in. (97 mm)	
Weight:		
Dry weight (without battery)	653 lb (296 kg)	560 lb (254 kg)
Performance:		
Maximum speed	12 mph (19 km/h)	12-15 mph (19-24 km/h)
Minimum turning radius	113.0 in. (2.8 m)	113.0 in. (2.8 m)
Seating capacity	2 persons	2 persons
Hill climbing ability	27° (50% grade) on pavement	20° (38% grade) on pavement

# SPECIFICATIONS

## ENGINE

Items	G16A
Description:	
Engine type	4-stroke, Gasoline, OHV
Number of cylinders	Single
Displacement	301 cm <sup>3</sup>
Bore x stroke	3.07 x 2.48 in. (78 x 63 mm)
Compression ratio	8.1:1
Rated output	9.5 hp (7.1 kw)/4000 rpm
Cooling system	Forced air cooled
Starting system	Starter
Ignition system	TCI Magneto
Spark plug type	BPR2ES
Spark plug gap	0.028-0.031 in. (0.7-0.8 mm)
Lubrication system	Splash
Engine oil type	YAMALUBE 4 cycle oil or SAE 10W30
Engine oil capacity	1.16 US qt (1.0 L, 0.24 Imp gal)
Oil change quantity	1.0 US qt (0.9 L, 0.19 Imp gal)

## TRANSMISSION

Items	G16A	
Transmission:		
Type	V-belt automatic centrifugal engagement	
V-belt width and outer line length	1.22 x 39.76 in. (31 x 1010 mm)	
V-belt wear limit	1.06 in. (27 mm)	
Governor:		
Type	Oil bath flyweight	
Factory speed setting	12 mph (19 km/h)	
Differential/reduction gear:	G16A	G16E
Differential type	Bevel gear	Bevel gear
Lubricant/capacity	SAE 90 gear oil/ 0.44 US qt (0.42 L, 0.09 Imp qt)	SAE 90 gear oil/ 0.32 US qt (0.3 L, 0.26 Imp qt)

## BATTERIES

Items	G16A	G16E
Battery:	BCI group 24, RC: minimum 75 min CCA: minimum 400A	BCI group GC-2 RC: minimum 105 min

# SPECIFICATIONS

## CHASSIS

Items	G16A and G16E
Steering system: Type Steering angle (L.H.) Steering angle (R.H.) Lubricant/capacity	Worm and pin 1.5 turn 1.5 turn Grease/3.0 US oz (0.09 L, 3.17 Imp oz)
Brakes: Brake system  Type of brake  Brake pedal freeplay linkage adjustment (Brake cable end play)	Mechanical drum brake on each rear wheel with self-adjusters. Dual internal expanding shoe. Leading/trailing shoes (self-adjusting)  25-30 mm 0.004-0.02 in. (0.1-0.5 mm)
Parking brake: Type	Foot type; parking brake with automatic release.
Release timing (Bolt heads round parallel to arm)	0.04 in. (1 mm)
Wheel: Tire size: Front Rear Rim size: Tire pressure:	18 x 8.50-8.00/4 PR 18 x 8.50-8.00/4 PR 7.00-1-8.00 For G16A: 16 psi (108 kPa, 1.1 kgf/cm <sup>2</sup> ) For G16E: 20 psi (137 kPa, 1.4 kgf/cm <sup>2</sup> )

# G16A WIRING DIAGRAM

# WIRING

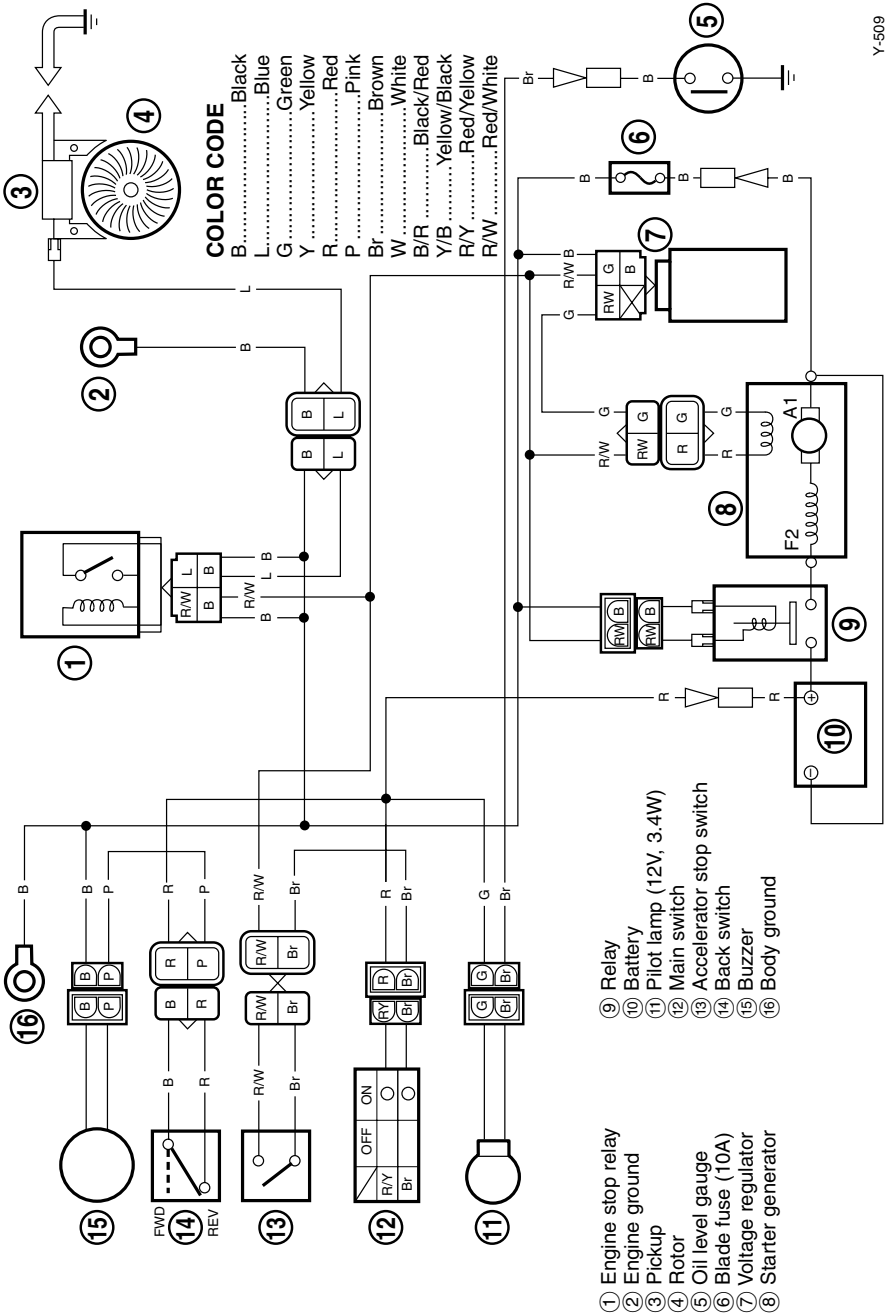

Y-509

# WIRING

# G16E WIRING DIAGRAM

- ① Back switch
- ② Buzzer
- ③ Accelerator stop switch
- ④ Diode (B)
- ⑤ Diode (A)
- ⑥ Main switch
- ⑦ Fuse (10A)
- ⑧ Battery
- ⑨ Receptacle
- ⑩ Throttle sensor
- ⑪ Controller
- ⑫ Motor
- ⑬ Shift switch
- ⑭ Limit switch

**COLOR CODE**

B	.....	Black
L	.....	Blue
G	.....	Green
Y	.....	Yellow
R	.....	Red
P	.....	Pink
Br	.....	Brown
W	.....	White
B/R	.....	Black/Red
Y/B	.....	Yellow/Black
R/Y	.....	Red/Yellow
R/W	.....	Red/White

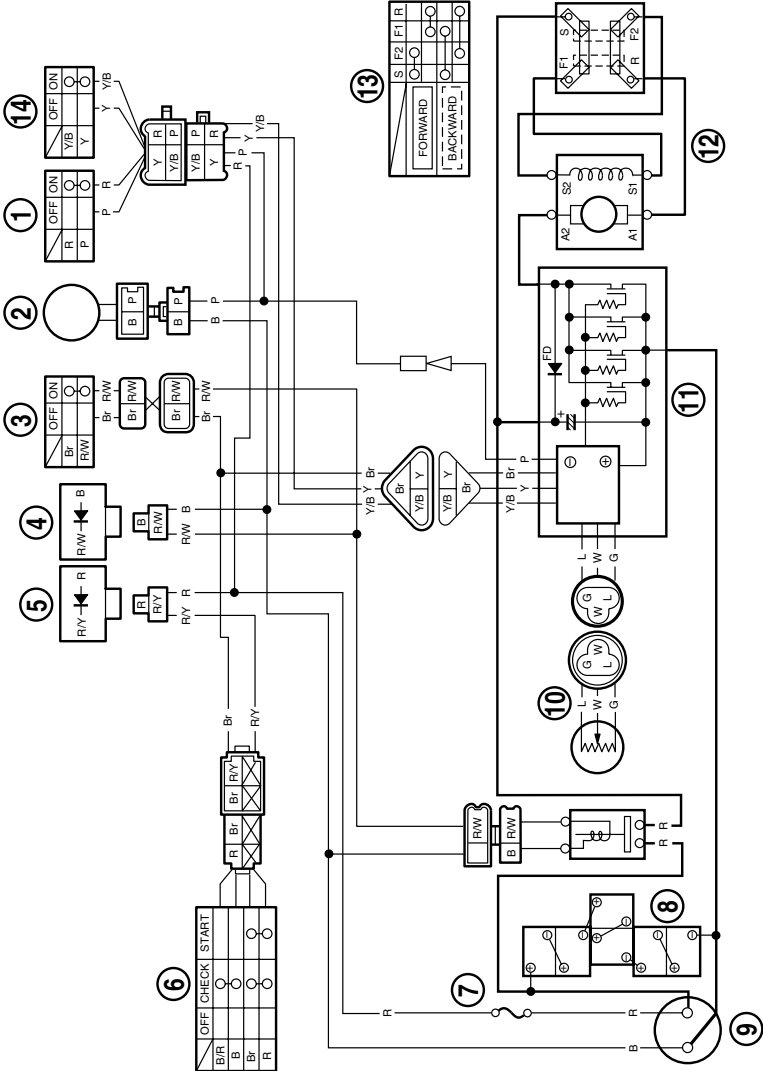

Y-59



**YAMAHA**  
**GENUINE**  
Parts & Accessories

07/12/01  
1PC - G16A/E O/M

LIT196261600



Yamaha Motor Corp., USA  
Cypress, California

YAMAHA YAMAHA YAMAHA YAMAHA YAMAHA YAMAHA YAMAHA YAMAHA YAMAHA YAMAHA YAMAHA YAMAHA YAMAHA YAMAHA YAMAHA YAMAHA  
MADE IN JAPAN YAMAHA YAMAHA YAMAHA YAMAHA YAMAHA YAMAHA YAMAHA YAMAHA YAMAHA YAMAHA YAMAHA YAMAHA YAMAHA YAMAHA YAMAHA  
YAMAHA YAMAHA YAMAHA YAMAHA YAMAHA YAMAHA YAMAHA YAMAHA YAMAHA YAMAHA YAMAHA YAMAHA YAMAHA YAMAHA YAMAHA  
MADE IN JAPAN YAMAHA YAMAHA YAMAHA YAMAHA YAMAHA YAMAHA YAMAHA YAMAHA YAMAHA YAMAHA YAMAHA YAMAHA YAMAHA YAMAHA YAMAHA

made in

**YAMAHA**

YAMAHA MOTOR  
MANUFACTURING CORP.  
OF AMERICA

Printed in U.S.A.  
KCC